

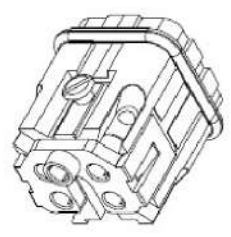

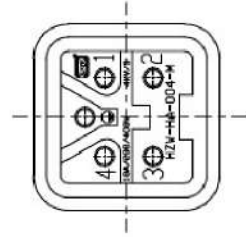

REVISION DATA				
SYM	ECN	DESCRIPTION	DATE	APPROVED

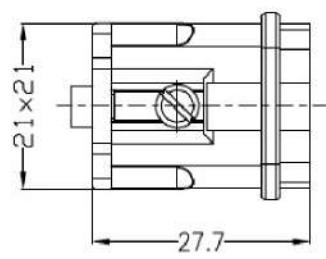
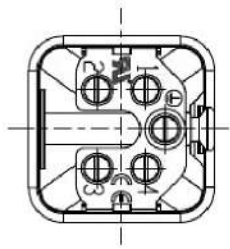

	SIGNATURE	DATE	Units	mm	 宁波欧科瑞连接器有限公司 NINGBO OKERUI CONNECTOR CO., LTD.	
DRAW			Size	A4	PART NAME	HZW-HA-004-M
DESIGN			Scale	1.5:1	Drawing NO.	61 201 004 111 REV
CHECK			Sheet	1/1	File path	OKR. HAP. 004M
APPROVE			Proj.			AO

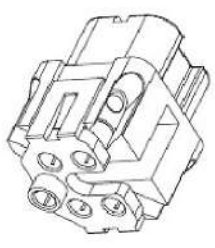
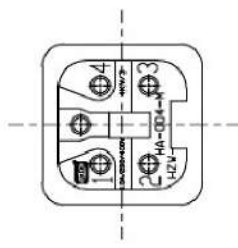
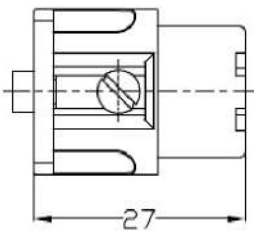
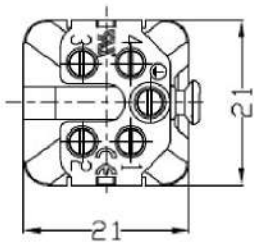
REVISION DATA				
SYM	ECN	DESCRIPTION	DATE	APPROVED



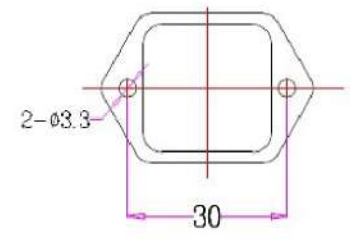
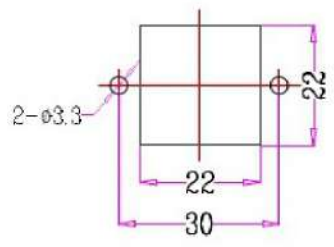
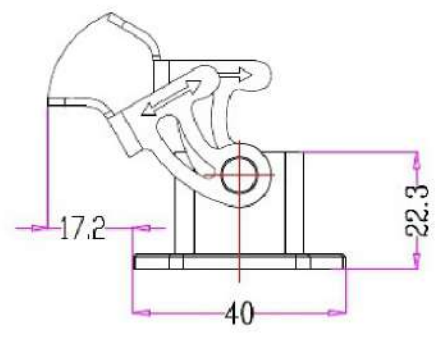
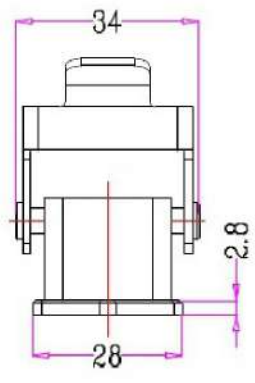

	SIGNATURE	DATE	Units	mm	 宁波欧科瑞连接器有限公司 NINGBO OKERUI CONNECTOR CO., LTD.		
DRAW			Size	A4			
DESIGN			Scale	1.5:1	PART NAME	HZW-HA-004-F	
CHECK			Sheet	1/1	Drawing NO.	61 201 004 112	REV
APPROVE			Proj.		File path	OKR. HAP. 004F	A0

REVISION DATA				
SYM	REN	DESCRIPTION	DATE	APPROVED





Panel cut out

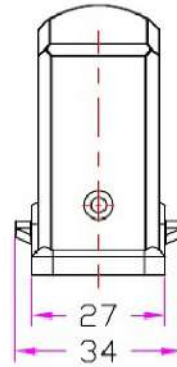
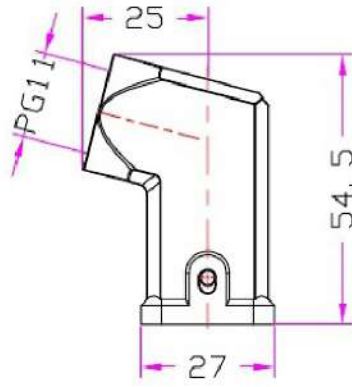

	SIGNATURE	DATE	Units	mm	 宁波欧科瑞连接器有限公司 NINGBO OUKERUI CONNECTOR CO., LTD.	
DRAW			Size	A4	PART NAME	HZW-H3A-ST-1PL
DESIGN			Scale	1:1	Drawing NO.	81 201 003 311
CHECK			Sheet	1/1	REV	
APPROVE			Proj.		File path	OKR_H3A_3AL11 A0

REVISION DATA				
SYM	ECN	DESCRIPTION	DATE	APPROVED



	SIGNATURE	DATE	Units	mm	 宁波欧科瑞连接器有限公司 NINGBO OKERUI CONNECTOR CO., LTD.	
DRAW			Size	A4	PART NAME	HZW-H3A-SK-2g-PG11
DESIGN			Scale	1:1	Drawing NO.	81 201 003 211
CHECK			Sheet	1/1	REV	
APPROVE			Proj.		File path	OKR.H3A.3AG11